

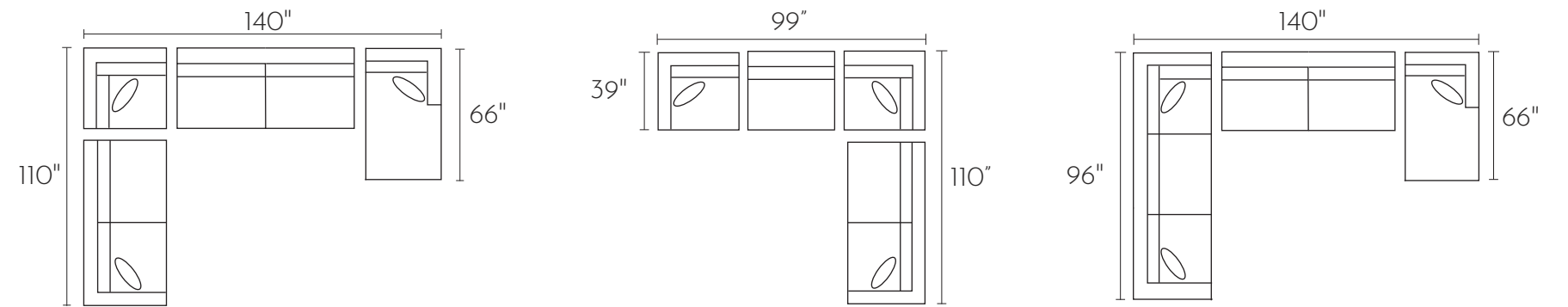

## 378 CROSBY

Crosby is a casual take on a modern silhouette. Tufted and tailored backs provide a streamlined look while the soft dome arms give you a relaxed family room feel.

### \*POPULAR CONFIGURATIONS CONT.



-26L / -15 / -03 / -82R  
\*SHOWN IN PHOTO

-04L / -10 / -15 / -26R

-32L / -03 / -82R

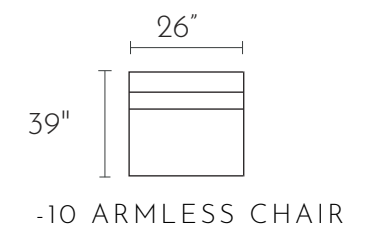
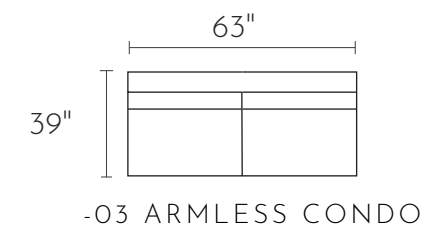
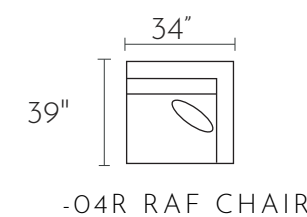
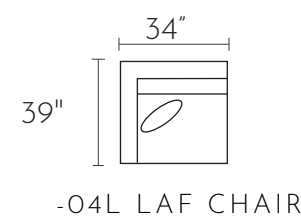
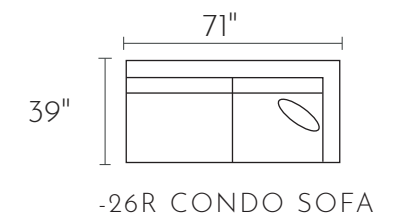
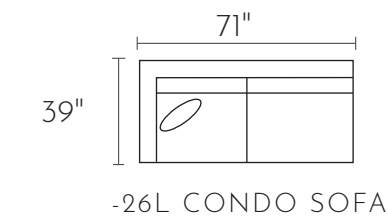
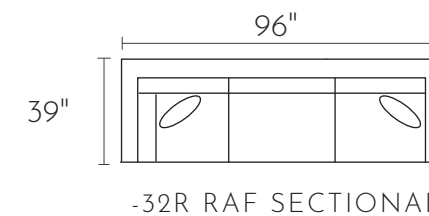
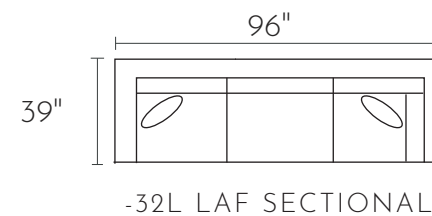
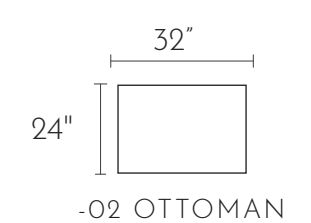
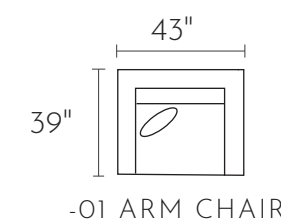
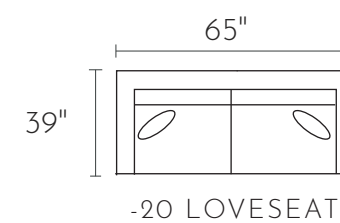
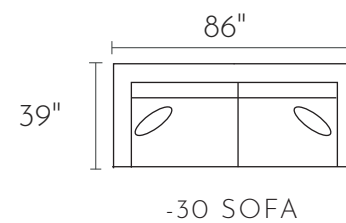

### \*POPULAR CONFIGURATIONS

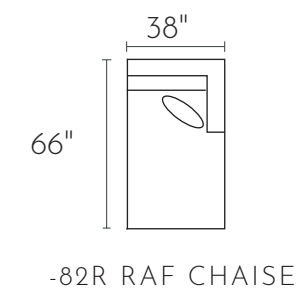
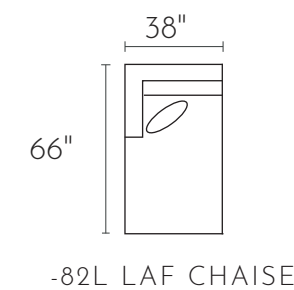
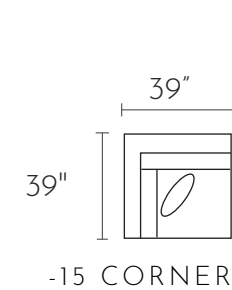
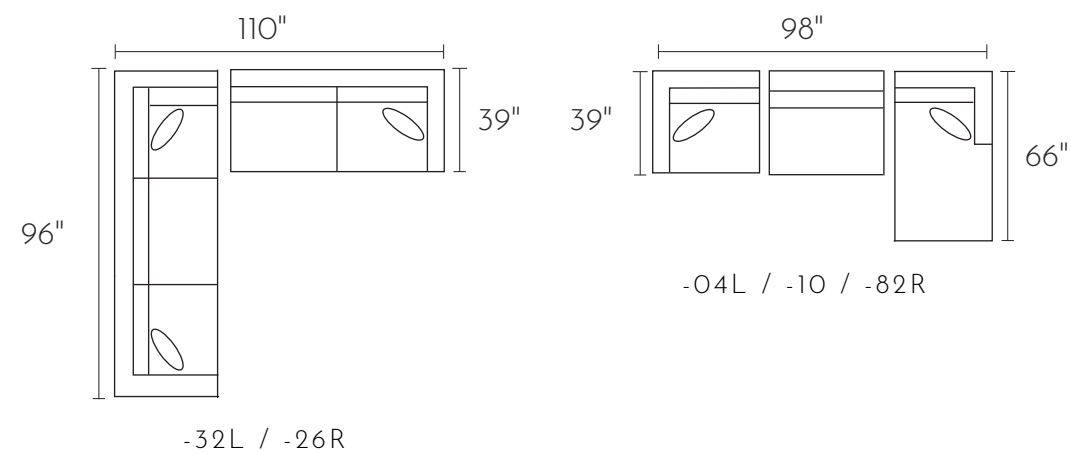

\*ALL DIMENSIONS ARE APPROXIMATE